

CAD/CAM/CAE

Design of Jigs and Fixtures for Hydraulic Press Machine

Taufik, R.S.* , Hirmanto, S., Sivarao, Hambali, A., and Tajul, A.A

Faculty of Manufacturing Engineering, Universiti Teknikal Malaysia Melaka, Durian Tunggal, 76100 Melaka, Malaysia

*Corresponding Author: taufik@utem.edu.my +60 6 3316899

Abstract –This paper presents the design of jigs and fixtures for hydraulic press machine in manufacturing industries. The current problem in industry is facing the utilization of hydraulic press machine when the demand has increased which occurs on the gripping or holding the workpiece securely. The main objective of this study is to propose a new design of jigs and fixtures for hydraulic press to carry out the gripping problem from existing design. Several design concepts were generated and simulated to analyze using ANSYS software. The design parameters such as maximum deformation, maximum shear stress, number of contact faces, and maximum holding force were presented. Based on the simulation result, the improvement of new jigs and fixtures design for hydraulic press machine was achieved. Copyright © 2012 Department of industrial engineering. All rights reserved.

Keywords: Design, simulation, multi vacuum manifold

1 Introduction

In the early years, interactive and semi-interactive jig and fixture design techniques were built on top of commercial CAD systems and expert system tools. These approaches were mainly concerned with fixture configuration and analysis on the other aspects such as workpiece fixture in the cutting tool interactions [1]. A comprehensive fixture research plan involves the analysis at different computational levels, geometric, kinematic, force and deformation analysis [2].

Geometric analysis is strongly related parameter with fixture planning and spatial reasoning [2]. It determines the selection of the type and number of fixture elements, the order of datum planes, support and locating elements [3]. The analysis also includes the checking of interference between workpiece and fixture elements, as well as cutting tools.

Gandhi and Thompson [4] proposed a methodology for the automated design of modular fixtures. Some of the semi-automated systems were developed by Jiang et al. [5] and Markus [4]. In 1991, Nee and Kumar [7] developed an automated fixture design system that integrates CAD with an expert system shell.

Other systems using a 3-D solid modeller, an expert-system shell and a rule-based technique have been reported by Lim and Knight [8], and Ngoi et al. [9], respectively. These systems are capable of automatically

generating partial or complete fixture solutions for simple prismatic workpieces, based on the geometric analysis. Most of the systems are based on modular fixtures.

Kinematic analysis is used to resolve whether a fixture formation is able to precisely locate and offer complete constraint to a workpiece. Previous work on fixture design automation offers quite small consideration in providing a comprehensive fixture element database and effective assembly strategies for the generation and construction of modular fixtures [2].

Deformation of the workpiece may cause dimensional problems in machining. Supports and locators are used in order to reduce the error caused by elastic deformation of the workpiece. The optimization of support, locator and clamp locations is a critical problem to minimize the geometric error in workpiece machining [10].

With the development of the CAD/CAPP/CAM and the wide application of CNC technique in the manufacturing, the traditional method for the jig and fixture design has not been adapted to the demands of complexity and variety in the practical production with vary of products and more rapid. Computer Aided Fixture Design (CAFD) is one of an effective way to solve the current problem [11].

According to the Li et al. [11], the designer's

participation and experience are necessary for the traditional CAFD system and a new design system. The purpose of the special jigs and fixtures development by applying artificial intelligence (AI) technology into the CAFD system, using the theory of the expert system and 3D modeling technology.

The assembly of modular fixtures is configured to the fixture elements such as locators, clamps and supports on the base-plate according to a fixture. The determination of the locating, supporting and clamping points for the assembly of modular fixtures is the main issue in fixture design automation [2], [12].

New approach was proposed using projected envelope of workpiece to determine the locating and clamping points [13]. This method reduces difficulty the fixture configuration and could be practical for non-prismatic parts. However, the system does not consider the size of the modular fixture elements and interference between the elements, the machining envelope and the workpiece. Another approach was developed the geometric reasoning method to determine the locating and clamping points [14]. Conversely, a detailed assembly method has not been proposed.

A technique was proposed using the spatial representation technique for automatic assembly of modular fixture elements [15]. The system uses a T-slot modular fixture system. However, the positions and types of locating, clamping and supporting elements were given as the inputs to the system.

Another techniques was explained the treating a machined workpiece as a rigid body [16], [17]. The authors applied restraint analysis to a fixture with frictionless or frictional surface contacts and a linear model for predicting the impact of locator and clamp placement on workpiece displacement throughout machining operations.

The current problem in industry is facing the utilization of hydraulic press machine. The drawback of this machine occurs on the gripping or holding the workpiece securely. It requires the new design of jigs and fixture to reduce loading and unloading the workpiece. There is a lack of the current clamping of jig and fixture in the Hydraulic Press Machine. In additional, the clamping jig and fixture mechanism of the machine fail to perform successfully if the workpiece in wet and oily condition. This problem was made the machine operator to dry and clean the wet and oily round bar (workpiece) before pressing process can be performed. This practice increases the cycle time of the product. Therefore, this research presents the new jig and fixture design for all conditions to ensure the pressing process can be performed successfully.

2 Materials and Method

This study focuses on three parameters such as, distance between inlets used in manifold system, number of inlets used, and the size between inlet and outlet. There were two design concepts to be considered in this study. This concept designs were set to meet the gripping problem and cost effectiveness. Figure 1 shows the design concept A with 'V' shape.

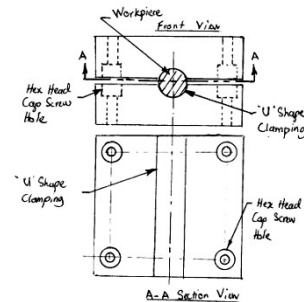

Figure 1. Concept A 'V' shape

Figure 2 shows the design concept B "U" shape with knurling that has advantage such as better gripping and less energy consumed.

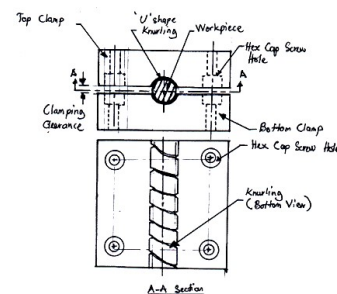

Figure 2. Concept B 'U' shape with knurling

The new designs of jig and fixture have been designed to clamp a round bar cylindrical workpiece. In this study two diameters to be considered for the analysis purposes, $\varnothing 16\text{mm}$ and $\varnothing 12\text{mm}$. The new design of jig and fixture will be analyzed and focused on the simulation using engineering analysis software. This study focuses on the cylindrical workpiece to determine the maximum holding force which the jig and fixture provides complete constraint to a cylindrical workpiece.

The clamping force at the jig and fixture to the cylindrical workpiece is produced from the double acting hydraulic cylinder. For this Hydraulic Press Machine, it consists of two difference specification of hydraulic cylinder as shown in the Table 1.

Table 1. Double Acting Hydraulic Cylinder Specification for Hydraulic Press Machine (JBSB, 2010)

Hydraulic Cylinder	All Pump Pressure at 3447 kPa				
	Bore (mm)	Stroke (mm)	Rod Diameter (mm)	Rod Area, (mm ²)	Extend Force (kN)
Cylinder 1	177.8	152.4	88.9	6206.44	72.5
Cylinder 2	177.8	406.4	101.6	8103.21	72.5

The current mechanism of jig and fixture design in the machine failed to perform successfully to the desired force that produced by the hydraulic cylinder (16286lbs). The maximum holding force was the importance parameter to determine whether the new jig and fixture configuration was able to locate correctly and provide complete constraints to a workpiece. The maximum holding force was the maximum force that produced by the jig and fixture relevant magnitude to apply force to keep the workpiece in static condition.

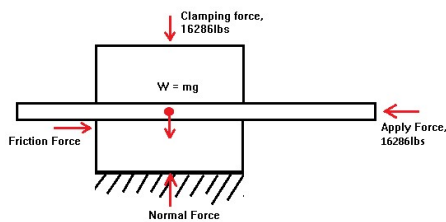

Figure 3. Free body diagram of the top and bottom clamping jig and fixture during pressing process.

Figure 3 shows the maximum holding force acting as a friction force during the pressing process. Frictional force can be expressed as:

$$F_f = \mu N \quad (1)$$

where

F_f = frictional force (N, lb)

μ = static (μ_s) frictional coefficient

N = normal force (N, lb)

Static friction, μ_s is friction between two solid objects that are not moving relatively to each other. The maximum possible friction force between two surfaces of the jig and fixture prior to sliding begins.

The normal force for an object pulled or pushed horizontally, the normal force, N , is simply the weight:

$$N = m g \quad (2)$$

where

m = mass of the object (kg, slugs)

g = acceleration of gravity (9.81 m/s², 32 ft/s²)

However, in this case, the clamping force needs to be considered into the calculation by expanding the equation (2), where:

$$N = m g + F_{clamping} \quad (3)$$

$$N = (3.03 \text{ kg} \times 9.81 \text{ m/s}^2) + 72444 \text{ N}$$

$$N = 72474 \text{ N}$$

Table 2. Approximate coefficients of friction (www.engineershandbook.com, 2006)

Material		Static friction, μ_s	
		Dry & clean	Lubricated
Steel	Steel	0.80	0.16

By using equation (1) and assuming the static coefficients in lubricated condition as shown in Table 2:

Finding the Friction Force:

$$F_f = \mu_s \cdot N = 0.16 \times 72474 \text{ N} = 11595.84 \text{ N}$$

Theoretically, the sliding will not be performed until the friction force reaches the value from zero up to 11595.84 N. However, the apply force was 72444 N, which was more than the friction force. This calculation proved that the current jig and fixture fail to provide complete constrains to the workpiece during the pressing process where the pressing force is 72444 N. It is found that the more force applied than the maximum holding force, the jig and fixture only provides the complete constrains to the workpiece until 11595.84 N. The larger force applied than friction force leads the sliding or slip during machining process.

In this research, the ANSYS Workbench 12.0 software is used to perform Finite Element Analysis. By using ANSYS, different types of physics can be integrated within FEA model to predict such as stresses, strains, displacements. It is an effective technique to predict the performance of a structure, mechanism or process virtually as close as in real time. In this study, dynamic transient structural analysis is used to simulate to predict the dynamic response of a structure under the action of general time dependent loads. The apply load was set to time-varying load from 0 N to 72444 N and the displacements, strains, stresses, and forces in a structure as it responds were observed. The basic equation of motion solved by a transient dynamic analysis is

$$(M)\{\ddot{u}\} + (C)\{\dot{u}\} + (K)\{u\} = \{F(t)\} \quad (4)$$

where:

(M) = mass matrix

(C) = damping matrix

(K) = stiffness matrix

$\{\ddot{u}\}$ = nodal acceleration vector

$\{\dot{u}\}$ = nodal velocity vector

$\{u\}$ = nodal displacement vector

$\{F(t)\}$ = load vector

3 RESULTS AND DISCUSSION

Physical deformations can be calculated on inside a part or an assembly. Fixed supports prevent deformation locations, without a fixed support usually experience deformation relative to the original location. Deformations were presented relative to the part or assembly coordinate system.

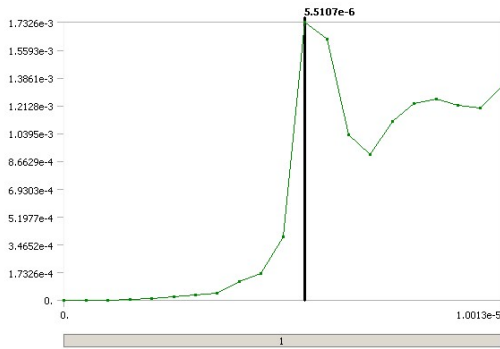

Figure 4. Result of Total Deformation for current design of jig & fixture

Figure 4 shows the result of the total deformation for the current design with respect to the cylindrical workpiece movement. As shown in the figure, it is found that in the 5.5107e-6 s, a slip occurs which carry the maximum total deformation of 1.7326e-3 mm. This slip occurs because a sudden deformation during short period of time.

Figure 5 shows the maximum shear stress τ_{max} , also referred to as the maximum shear stress, and presented by plotting Mohr's circles to determine the principal stresses.

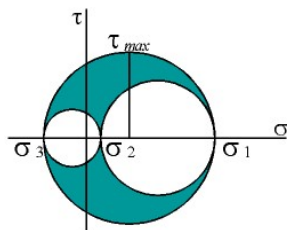

Figure 5. Theory of maximum shear stress by using plotting Mohr's circles.

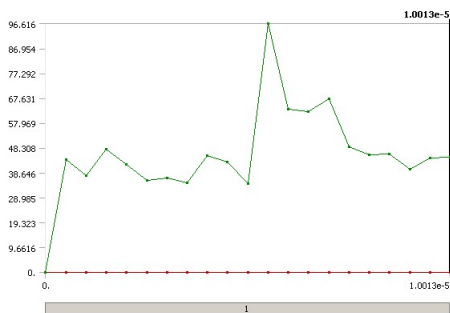

Figure 6. Result of the Maximum Shear Stress for the current design jig & fixture.

The result of the maximum shear stress for the current design jig & fixture was shown as in Figure 6. The result obtained by applying the load that directly proportional to the time step. It is found that the slip occur during 5.5107e-6 s of time step. The slip condition produces the maximum value over time to the jig and fixture which is 96.616MPa. This is due to shear stress (τ) represents the friction force from a cylindrical workpiece surface contact on a body of the jig and fixture. The result shows from forces applied parallel to the cylindrical workpiece surface.

Figure 7 shows the contour distribution of the shear stress for the current jig & fixture. It is clear that the cross section area of the jig & fixture was presented. Based on the result, the applied force parallel to the contact surface of the jig and fixture produces two major points that have the average contact surface with the cylindrical workpiece at 44.84 MPa. The zoom area as shown in the figure shown the maximum contact shear stress produced by the applied force parallel to the workpiece.

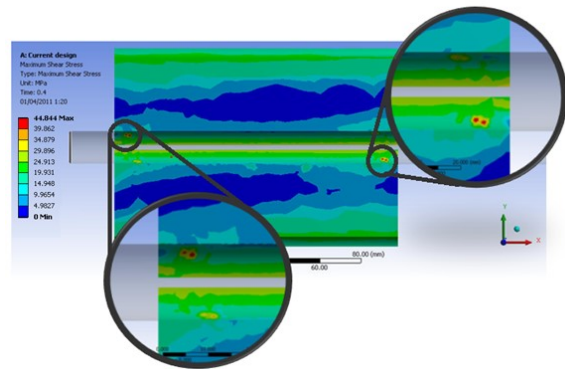

Figure 6. Contour of maximum shear stress for current design jig and fixture

By referring to the Figure 7, the maximum total deformation is 6.5933e-4 mm which occurs at the end of the analysis or specifically at 1e-5 s. It is determined that there was no excessive value, thus it can be concluded that there was no slip occurs. However, there were still small deformations during the analysis.

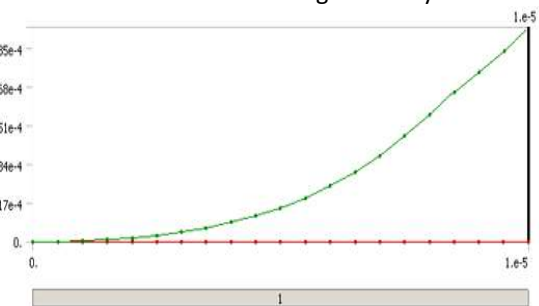

Figure 7. Result of Total deformation for improvement design

Figure 8 shows the result of the maximum shear stress for the improvement design jig and fixture. It is found that there were no slip occurs during the

simulation, the maximum value over time were occurs in the contact surface of the jig and fixture with the cylindrical workpiece with value of 47.691 MPa.

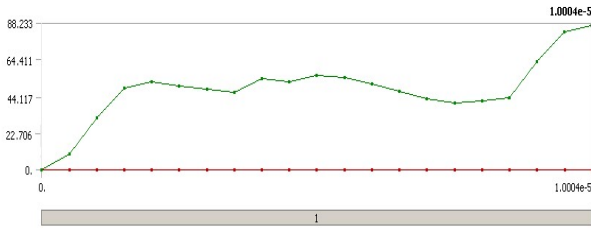

Figure 8. Result of the maximum shear stress for the improvement design

Figure 9 shows the contour distribution of the maximum shears stress for the current jig and fixture. The cross-section area of the jig and fixture shows the applied force parallel to the contact surface of the jig and fixture, and produces the maximum value in each end of the knurling edge which has the average contact surface with the cylindrical workpiece. The value obtained is 47.691 MPa. It is found that the red contour in each end of the knurling edge which produces the maximum shear stress during the simulation.

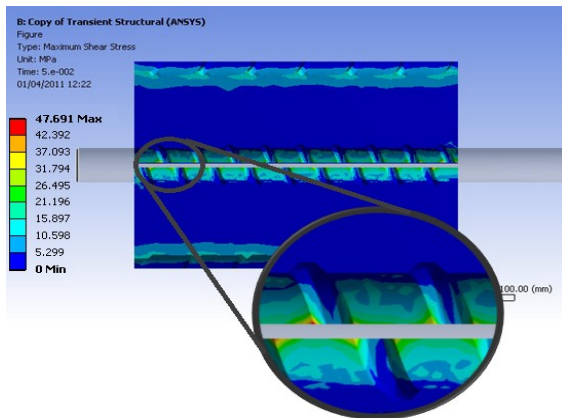

Figure 9. Contour result of maximum shear stress for improvement

Figure 10 shows the result of the total deformation with respect to the applied force for the current design. It is shown that at time 5.5107e-6 s a slip has occur thus that mean the clamping jig and fixture for the current design has excide the holding force. A projection line has been made at the exact time the slip occur with the maximum holding force for the current design was 11250 N.

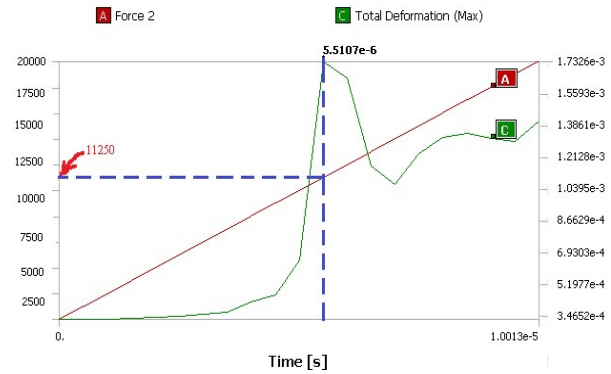

Figure 10. Result of the total deformation with respect to the applied force for the current design.

In contrast, there was no slip occur during the simulation for the improvement design jig and fixture. Figure 11 shows there were no excessive deformations or slip condition occur as compared with the current design. However, there were small deformation exist during the simulation which was less than 0.00060851 mm and it can be neglected.

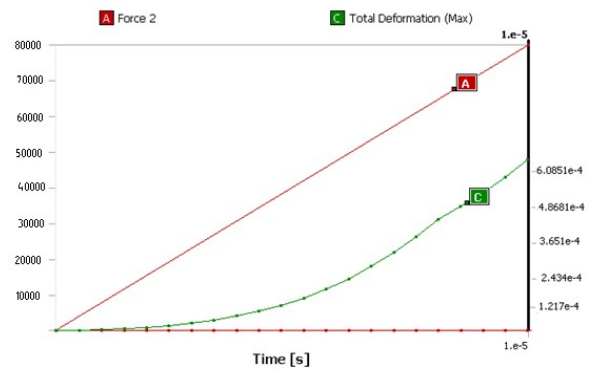

Figure 11. Result of the total deformation with respect to the applied force for the improvement design.

The different number of contact faces between this both concepts has arisen with excessive different result. The number of total contact surface between the rigid body cylindrical workpiece and the jig and fixture are one of the parameter that will influence the maximum applied force. Table 3 shows the summary result of both design jig and fixture and the parameter that influence the slip condition to be occur.

Table 3. Comparison the designs with respect to the parameter based on the simulation result

Design Concept	Parameter			
	Maximum Deformation (mm)	Max. Shear Stress (MPa)	Number of Contact Faces	Max. Holding Force (kN)
Current Design (Concept A)	1.7326e-3	44.84	1	11.25
Improvement Design (Concept B)	0.6593e-3	47.691	10	80.00

4 Conclusion

The design parameters of jig and fixture for Hydraulic Press Machine have been investigated. The jig and fixture design has been analyzed using Transient Structural Analysis (ANSYS). The design parameters such as maximum deformation, maximum shear stress, number of contact faces, and maximum holding force were presented. In addition, the new design jig and fixture has been proposed for Hydraulic Press Machine. It is found that the gripping ability was significantly factor that affected to the clamping and holding the workpiece securely during machining process.

The proposed design shows successfully safe for the machining process based on the simulation result. The new jigs and fixtures design for hydraulic press machine has proven gradually and provides complete constrains to the cylindrical workpiece during the pressing process.

Acknowledgements

The authors gratefully acknowledged the technical support from the Universiti Teknikal Malaysia Melaka (UTeM) Short Term Grant PJP/2011/FKP (14A) – S881.

References

- [1] Hoffman, E. G. Jig and fixture design. United State of America: Delmar Learning, 2003.
- [2] Nee, A. Y., Tao, Z. J., & Kumar, A. S. An advanced treatise on fixture design and planning, Volume 1. Singapore: World Scientific Publishing, 2004.
- [3] Joshi, P. H. Jigs and fixtures Design Manual. New York: McGraw-Hill, 2003.
- [4] Gandhi, M., & Thompson, B. (1986). Automated Design of Modular Fixtures for Flexible Manufacturing Systems. *Journal of Manufacturing Systems*, 1986, 243-252.
- [5] Jiang, W., Wang, S., & Cai, Y. (1988). Computer-aided Group Fixture Design *Annals of the CIRP*. 145-148.
- [6] Markus, A. Strategies for the Automated Generation of Modular Fixtures. *ASME Proc. Manufacturing International '88 Symposium Manufacturing Systems: Design, Integration and Control*, 1988, 97-103.
- [7] Nee, A., & Kumar, A. S. A Framework for an Object/rule-based Automated Fixture Design System, 40(1). *Annals of the CIRP* , 147-151, 1991.
- [8] Lim, B., & Knight, J. Holdex - Holding Device Expert System. *Proc.1st Int. Conf Applications of Artificial Intelligence in Engineering Problems*, 1986, 483-493.
- [9] Ngoi, B., Whybrew, K., & Astley, R. (1990). Computer Aided Assembly of Modular Fixturing Systems. *Proc. Asia-Pacific Industrial Automation '90 Conf. Automation Singapore*, 1990, pp. 593-607.
- [10] Kaya, N. machining Fixture Locating and Clamping Position Optimization Using Genetic Algorithms. *Computers in Industry*, 2006, pp. 112-120.
- [11] Li, K., Liu, R., Bai, G., & Zhang, P. Development of an Intelligent Jig and Fixture Design System, 2006.
- [12] Taufik, Beh, T., & Maidin, S. Design and Development of LED Bending Machine Fixture. *World engineering Congress*, 2007, pp. 1-8, Penang.
- [13] Trappey, A., & Matrubhutam, S. Fixture Configuration Using Projective Geometry. *Journal of Manufacturing Systems*, 12(6), 1993, pp.486-495.
- [14] Chou. Y. Geometric Reasoning for Layout Design of Machining Fixtures. *Int. J. Computer Integrated Manufacturing*, Vol.7, No.3, 1994. pp. 175-185.
- [15] Whybrew, K., & Ngoi, B. Computer Aided Design of Modular Fixture Assembly. *International Journal of Advanced Manufacturing Technology*, 7(5), 1992, pp. 267-276.
- [16] DeMeter, E. Restraint Analysis of Fixtures which Rely on Surface Contact. *Journal of Engineering for Industry*, 116(2), 1994a, pp. 207-215.
- [17] DeMeter, E. The Min-Max Load Criteria as a Measure of Machining Fixture Performance. *Journal of Engineering for Industry*, 116(11), 1994b, pp.500-507.